



# **CONO ISO DIN/69871**

PROGRAMA

						
PAG. 4-5	PAG. 6	PAG. 7	PAG. 7	PAG. 8	PAG. 8	PAG. 9
						
PAG. 10-11	PAG. 12	PAG. 12	PAG. 12	PAG. 13	PAG. 14-17	PAG. 18
						
PAG. 19	PAG. 19	PAG. 20-21	PAG. 22-24	PAG. 24	PAG. 25	PAG. 26-27
						
PAG. 27	PAG. 28	PAG. 29	PAG. 29	PAG. 30	PAG. 30	PAG. 31
						
PAG. 31-32	PAG. 33	PAG. 34	PAG. 34	PAG. 35	PAG. 36	PAG. 37
						
PAG. 38-40	PAG. 41	PAG. 42	PAG. 42	PAG. 43		

● Opcional **DOBLE CONTACTO**

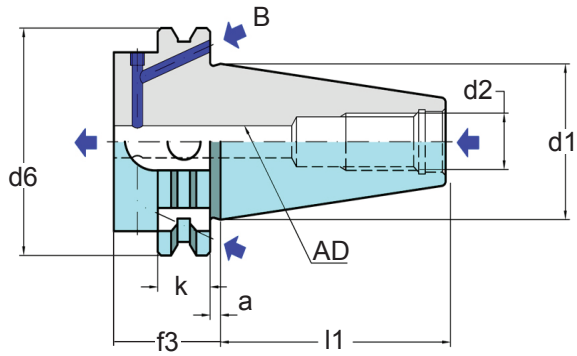
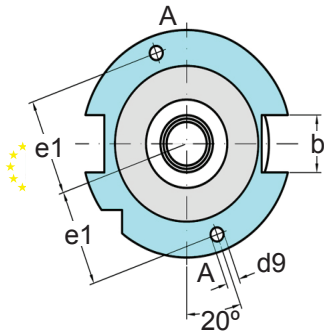

CONO TAPER	FORMA FORM	d1	d2	d6	l1	a	k	f3	b	d9	e1
TC30	AD	31.75	M12	50	47.8	3.2	15.9	35	16.1	-	-
TCB40	AD+B	44.45	M16	63.55	68.40	3.2	15.9	35	16.1	4	27
TCB45	AD+B	57.15	M20	82.55	82.7	3.2	15.9	35	19.3	5	35
TCB50	AD+B	69.85	M24	97.50	101.75	3.2	15.9	35	25.7	6	42

Forma AD+B = TCB

Forma AD = TC

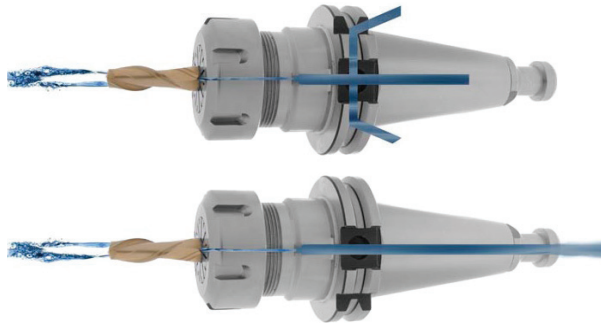

**DOBLE CONTACTO**



CONO TAPER	FORMA FORM
DTC40	AD
DTC50	AD

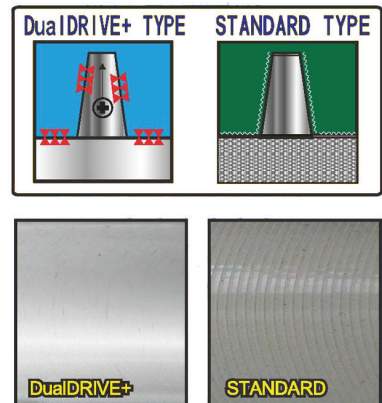
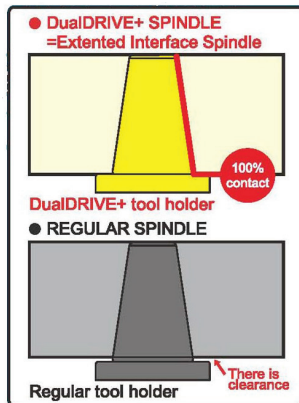

DIN/69871

Porta pinzas ER tuerca STANDARD  
Collet chucks ER STANDARD nut

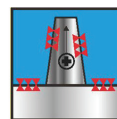
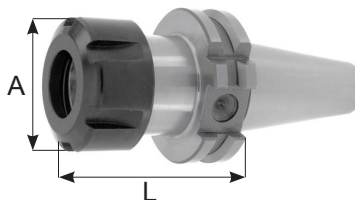

100% contact

\* G2.5 / 25.000rpm  
G6.3 / 15.000rpm  
Face contact

TC30

REFERENCIA	CAP	RPM	FORMA	L	A
TC30L63ER16	1 ÷ 10	15.000	AD	63	32
TC30L100ER16	1 ÷ 14			100	
TC30L63ER20				63	35
TC30L63ER25	1 ÷ 20			63	
TC30L90ER25				90	42
TC30L63ER32	2 ÷ 22			63	
TC30L100ER32		100	50		

TC40

REFERENCIA	CAP	RPM	FORMA	L	A	
TCB40L70ER16 *	1 ÷ 10	15.000	AD+B	70	32	
TCB40L100ER16 *				100		
TCB40L120ER16				120		
TCB40L130ER16				130		35
TCB40L150ER16				150		
TCB40L160ER16				160		
TCB40L200ER16	200					
TCB40L70ER20 *	1 ÷ 14	15.000	AD+B	70	35	
TCB40L100ER20 *				100		
TCB40L130ER20				130		
TCB40L160ER20				160		
TCB40L70ER25 *	1 ÷ 20	15.000	AD+B	70	42	
TCB40L100ER25 *				100		
TCB40L130ER25				130		
TCB40L160ER25				160		
TCB40L200ER25				200		
TCB40L47ER32	2 ÷ 22	15.000	AD+B	47	50	
TCB40L70ER32 *				70		
TCB40L100ER32 *				100		
TCB40L130ER32				130		
TCB40L160ER32				160		
TCB40L200ER32				200		
TCB40L70ER40 *	3 ÷ 30	15.000	AD+B	70	63	
TCB40L100ER40 *				100		
TCB40L130ER40				130		
TCB40L160ER40				160		
TCB40L200ER40				200		
TCB40L85ER50	6 ÷ 34	15.000	AD+B	85	78	

\* "Face contact" + "D" (DTCB40L70ER16)

TC45 - TC50 →

DIN/69871

Porta pinzas ER tuerca STANDARD  
Collet chucks ER STANDARD nut

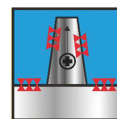
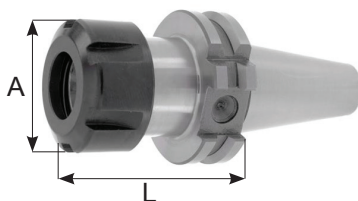

100% contact

\* G2.5 / 25.000rpm  
G6.3 / 15.000rpm  
Face contact

TC45

REFERENCIA	CAP	RPM	FORMA	L	A
TCB45L80ER32	2 ÷ 22	15.000	AD+B	80	50
TCB45L100ER32				100	
TCB45L80ER40	3 ÷ 30	15.000	AD+B	80	63

TC50

REFERENCIA	CAP	RPM	FORMA	L	A
TCB50L100ER16 *	1 ÷ 10	15.000	AD+B	100	28
TCB50L160ER16				160	
TCB50L200ER16				200	
TCB50L100ER20 *	1 ÷ 14	15.000	AD+B	100	34
TCB50L160ER20				160	
TCB50L80ER25 *	1 ÷ 20	15.000	AD+B	80	42
TCB50L100ER25 *				100	
TCB50L130ER25				130	
TCB50L160ER25				160	
TCB50L200ER25				200	
TCB50L80ER32 *	2 ÷ 22	15.000	AD+B	80	50
TCB50L100ER32 *				100	
TCB50L130ER32 *				130	
TCB50L160ER32 *				160	
TCB50L200ER32 *				200	
TCB50L250ER32				250	
TCB50L80ER40 *	3 ÷ 30	15.000	AD+B	80	63
TCB50L100ER40 *				100	
TCB50L130ER40 *				130	
TCB50L160ER40				160	
TCB50L200ER40				200	
TCB50L100ER50	6 ÷ 34	15.000	AD+B	100	78
TCB50L130ER50				130	
TCB50L160ER50				160	

\* "Face contact" + "D" (DTCB50L100ER16)

7

DIN/69871

Porta pinzas ER tuerca MINI  
Collet chucks ER MINI nut

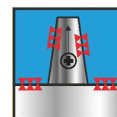
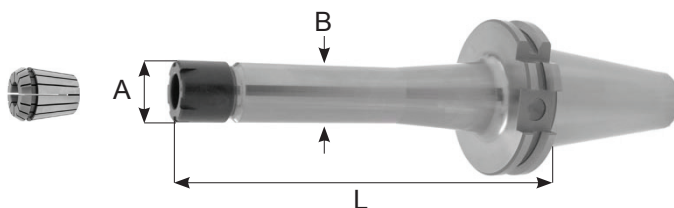

100% contact

\* G2.5 / 25.000rpm  
G6.3 / 15.000rpm  
Face contact

## TC40

REFERENCIA	CAP	RPM	FORMA	L	B	A
TCB40L130ER8M	1 ÷ 5	15.000	AD+B	130	12	12
TCB40L100ER11M *				100		
TCB40L125ER11M	1 ÷ 7	15.000	AD+B	125	16	16
TCB40L150ER11M				150		
TCB40L70ER16M				70		
TCB40L100ER16M *	1 ÷ 10	15.000	AD+B	100	22	22
TCB40L125ER16M				125		
TCB40L150ER16M				150		
TCB40L100ER20M *	1 ÷ 14	15.000	AD+B	100	28	28
TCB40L135ER20M				135		
TCB40L150ER20M				150		
TCB40L100ER25M	1 ÷ 20	15.000	AD+B	100	35	35
TCB40L150ER25M				150		
TCB40L200ER25M				200		

\* "Face contact" + "D" (DTCB40L100ER11M)

## TC50

REFERENCIA	CAP	RPM	FORMA	L	B	A
TCB50L100ER11M *	1 ÷ 7	15.000	AD+B	100	16	16
TCB50L130ER16M *	1 ÷ 10	15.000	AD+B	130	22	22
TCB50L160ER16M				160		
TCB50L200ER16M				200		
TCB50L130ER20M *	1 ÷ 14	15.000	AD+B	130	28	28
TCB50L130ER25M	1 ÷ 20	15.000	AD+B	130	35	35
TCB50L160ER25M				160		

\* "Face contact" + "D" (DTCB50L100ER11M)



DIN/69871

Porta pinzas extra corto  
Shorty Collet chucks

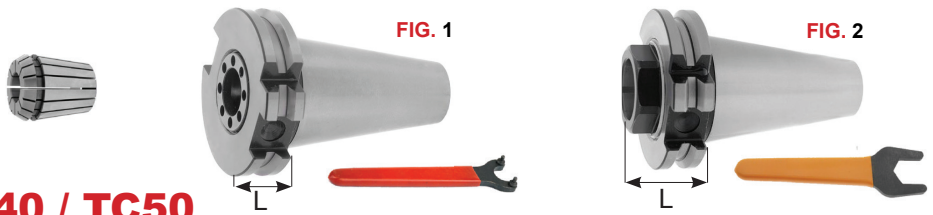

TC40 / TC50

REFERENCIA	CAP	RPM	FORMA	L	FIG
TC40L21ER25A	1 ÷ 20	12.000	AD	21	1
TC40L21ER32A	2 ÷ 22		AD	21	1
TC50L21ER32A	2 ÷ 22		AD	21	1
TCB40L40ER32A	2 ÷ 22		AD+B	40	1
TCB40L47ER32AEX			AD+B	47	2
TCB50L40ER32A	2 ÷ 22		AD+B	40	1
TCB50L47ER32AEX		AD+B	47	2	

DIN/69871

Porta pinzas ER regulación radial  
Radial adjustable collet chucks

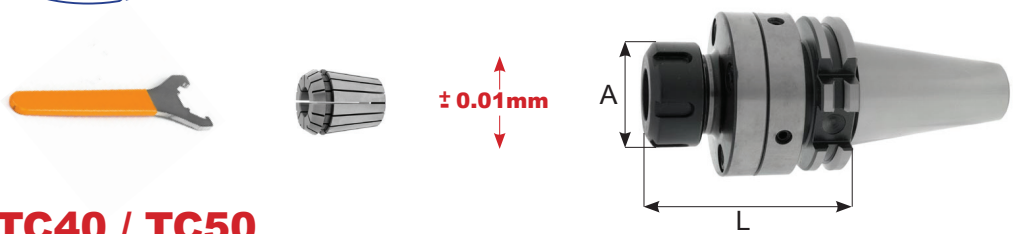

TC40 / TC50

REFERENCIA	CAP	FORMA	A	L
TCB40L93ER16RG	1 ÷ 10	AD+B	32	93
TCB40L95ER20RG	1 ÷ 14		35	95
TCB40L96ER25RG	1 ÷ 20		42	96
TCB40L97ER32RG	2 ÷ 22		50	97
TCB40L131ER40RG	3 ÷ 30		63	131
TCB50L93ER16RG	1 ÷ 10	AD+B	32	93
TCB50L95ER20RG	1 ÷ 14		35	95
TCB50L96ER25RG	1 ÷ 20		42	96
TCB50L97ER32RG	2 ÷ 22		50	97
TCB50L131ER40RG	3 ÷ 30		63	131

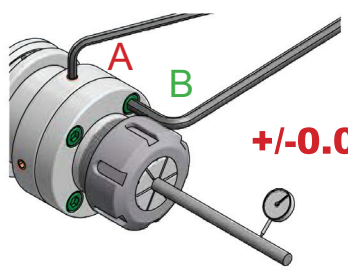

+/-0.01mm

"Afloje los tornillos B y ajuste el centrado con los tornillos A"  
"Loosen screws B and use screws A for radial adjustment"

Porta pinzas para pinza EOC DIN/6388 B  
Collet chucks EOC DIN/6388 B

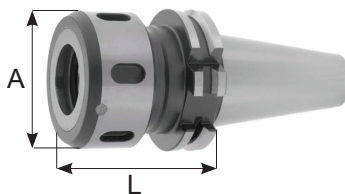

TC30 / TC40 / TC50

REFERENCIA	CAP	RPM	FORMA	L	A
TC30L60EOC16	2 ÷ 16	15.000	AD	60	43
TC30L80EOC25	2 ÷ 25			80	60
TCB40L70EOC16	2 ÷ 16	15.000	AD+B	70	43
TCB40L100EOC16				100	43
TCB40L70EOC25	2 ÷ 25			70	60
TCB40L100EOC25				100	60
TCB40L90EOC32	3 ÷ 32	90	72		
TCB50L70EOC16	2 ÷ 16	15.000	AD+B	70	43
TCB50L70EOC25	2 ÷ 25			70	60
TCB50L80EOC32	3 ÷ 32			80	72
TCB50L100EOC32				100	72

MAS/403BT

Porta pinzas SKS  
SKS - Collet chucks

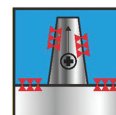
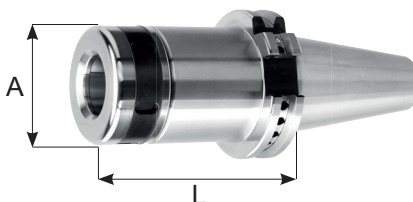

100% contact

\*

G2.5 / 25.000rpm  
G6.3 / 15.000rpm  
Face contact

TC40 / TC50

REFERENCIA	CAP	RPM	FORMA	L	A
TC40L90SKS10 *	2 ÷ 10	15.000	AD	90	30
TC40L120SKS10	2 ÷ 10			120	30
TC40L90SKS16 *	3 ÷ 16			90	40
TC40L90SKS20 *	3 ÷ 20			90	48.5
TC40L120SKS20	3 ÷ 20			120	48.5
TC40L90SKS25 *	3 ÷ 25			90	55.1
TC50L105SKS10	2 ÷ 10	15.000	AD	105	30
TC50L165SKS10	2 ÷ 10			165	30
TC50L105SKS20	3 ÷ 20			105	48.5
TC50L165SKS20	3 ÷ 20			165	48.5

\* "Face contact" + "D" (DTC40L90SKS10)



**MAS/403BT**

Porta pinzas gran apriete  
*Power milling chucks*

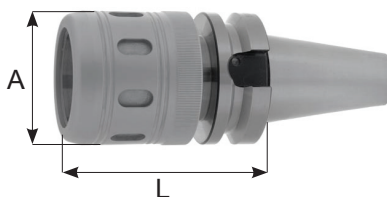

Refrigeración  
Interna  
Coolant flow

**TC30 / TC40 / TC50**

REFERENCIA	CAP	RPM	FORMA	L	A
TC30L100FP20	3 ÷ 16	15.000	AD	100	46
TCB40L75FP20	3 ÷ 16	15.000	AD+B	75	46
TCB40L95FP32	3 ÷ 25			95	62
TCB50L85FP20	3 ÷ 16	15.000	AD+B	85	46
TCB50L85FP32	3 ÷ 25			85	62

Estuche porta pinzas gran apriete  
*Straight shank collet chuck kit*



REFERENCIA	Capacidad
BTC30FP20	Pinza 4SR20 6 . 8 . 10 . 12 . 16
BTC40FP20	
BTC50FP20	
BTC40FP32	Pinza 4SR32 6 . 8 . 10 . 12 . 16 . 20 . 25
BTC50FP32	



DIN/69871

Porta herramientas hidráulico paso refrigerante  
Hydraulic chucks with coolant feed



Coolant

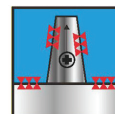
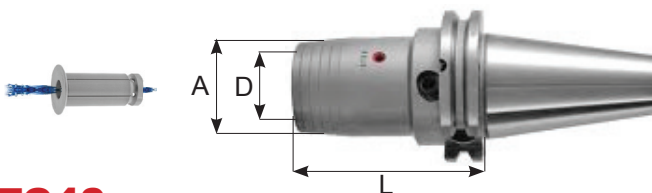

100% contact

TC30 / TC40

REFERENCIA	D	FORMA	L	A
TC30L60HD6 *	6	AD	60	45
TC30L64HD8 *	8		64	45
TC30L64HD10 *	10		64	45
TC30L72HD12 *	12		72	45
TC30L72HD14 *	14		72	45
TC30L72HD16 *	16		72	45
TC30L72HD18 *	18		72	45
TC30L90HD20 *	20		90	42
TC30L105HD25	25		105	45
TC30L135HD25	25		135	45
TC40L68HD6 *	6	AD	68	26
TC40L110HD6			110	
TC40L150HD6	8	AD	150	28
TC40L68HD8 *			68	
TC40L110HD8	110	AD	150	30
TC40L150HD8	150			
TC40L72HD10 *	10	AD	72	32
TC40L110HD10			110	
TC40L150HD10	150	AD	77	34
TC40L77HD12 *	77			
TC40L110HD12	110	AD	110	40
TC40L150HD12	150			
TC40L77HD14 *	14	AD	77	42
TC40L110HD14			110	
TC40L150HD14	150	AD	80	50
TC40L80HD16 *	80			
TC40L110HD16	110	AD	110	60
TC40L150HD16	150			
TC40L80HD18 *	18	AD	80	42
TC40L110HD18			110	
TC40L150HD18	150	AD	82	42
TC40L82HD20 *	82			
TC40L110HD20	110	AD	110	50
TC40L150HD20	150			
TC40L117HD25 *	25	AD	117	60
TC40L150HD25			150	
TC40L117HD32 *	32	AD	117	

AD+B (Sobre Pedido) AD+B (On request)

\* "Face contact" + "D" (DTC40L68HD6)

TC50 →

DIN/69871

Porta herramientas hidráulico paso refrigerante  
Hydraulic chucks with coolant feed



Coolant

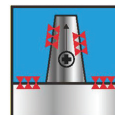
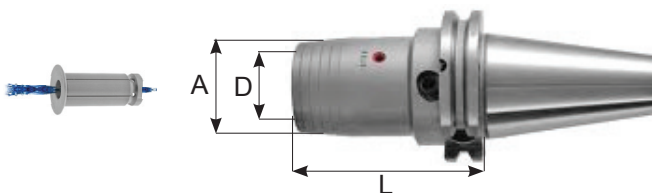

100% contact

TC50

REFERENCIA	D	FORMA	L	A
TC50L68HD6 *			68	
TC50L110HD6	6	AD	110	26
TC50L150HD6			150	
TC50L200HD6			200	
TC50L68HD8 *			68	
TC50L110HD8	8	AD	110	28
TC50L150HD8			150	
TC50L200HD8			200	
TC50L72HD10 *			72	
TC50L110HD10	10	AD	110	30
TC50L150HD10			150	
TC50L200HD10			200	
TC50L77HD12 *			77	
TC50L110HD12	12	AD	110	32
TC50L150HD12			150	
TC50L200HD12			200	
TC50L77HD14 *			77	
TC50L110HD14	14	AD	110	34
TC50L150HD14			150	
TC50L200HD14			200	
TC50L80HD16 *			80	
TC50L110HD16	16	AD	110	38
TC50L150HD16			150	
TC50L200HD16			200	
TC50L80HD18 *			80	
TC50L110HD18	18	AD	110	40
TC50L150HD18			150	
TC50L200HD18			200	
TC50L82HD20 *			82	
TC50L110HD20	20	AD	110	42
TC50L150HD20			150	
TC50L160HD20			160	
TC50L200HD20			200	
TC50L87HD25 *			87	
TC50L110HD25	25	AD	110	50
TC50L150HD25			150	
TC50L160HD25			160	
TC50L200HD25			200	
TC50L91HD32 *			91	
TC50L110HD32	32	AD	110	60
TC50L150HD32			150	
TC50L200HD32			200	
TC50L120HD40 *	40	AD	120	70
TC50L150HD40			150	
TC50L120HD50 *	50	AD	120	78

DIN/69871

Porta brocas con llave de gancho  
Drill chuck with hook wrench

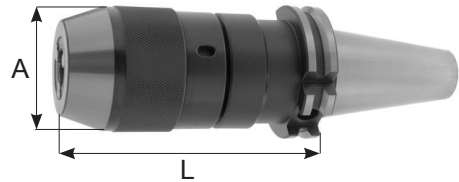

**TC30 / TC40 / TC50**

REFERENCIA	CAP	RPM	FORMA	L	A
TC30L110DCK13	1 ÷ 13	12.000	AD	110	50
TC40L100DCK13	1 ÷ 13			100	50
TC40L115DCK16	3 ÷ 16			115	57
TC50L100DCK13	1 ÷ 13			100	50
TC50L105DCK16	3 ÷ 16			105	57

7

DIN/69871

Porta brocas llave hexagonal con paso refrigerante  
Hexagonal key look drill chucks with coolant through

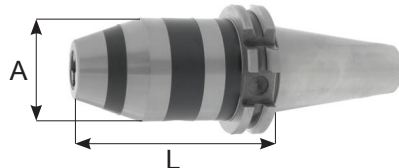
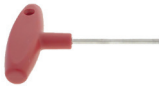

**TC40 / TC50**

REFERENCIA	CAP	RPM	FORMA	L	A
TC30L120DCK13	1 ÷ 13	12.000	AD	120	50
TCB40L90HD13	1 ÷ 13		AD+B	90	50
TCB40L95HD16	3 ÷ 16			95	50
TCB50L90DCK13	1 ÷ 13		90	50	
TCB50L95DCK16	3 ÷ 16		95	50	

DIN/69871

Porta brocas  
Drill chuck Arbors

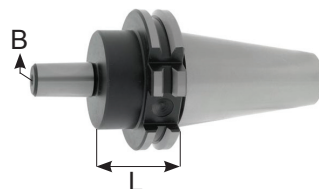

**TC30 / TC40 / TC50**

REFERENCIA	DIN	B	L
TC30L25B12	DIN/238	B12	25
TC30L25B16	DIN/238	B16	25
TC40L40B12	DIN/238	B12	40
TC40L40B16	DIN/238	B16	40
TC40L40B18	DIN/238	B18	40
TC50L40B16	DIN/238	B16	40
TC50L40B18	DIN/238	B18	40



Porta escariador flotante con paso refrigerante  
Floating reamer holder with coolant flow



Flotación

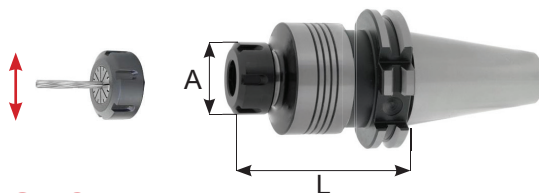

Refrigeración  
Interna  
Coolant flow

TC30 / TC40 / TC50

REFERENCIA	CAP	PINZA	FORMA	FLOT	L	A
TC30RM11	1 ÷ 7	ER11	AD	± 1 mm	75	19
TC30RM16	1 ÷ 10	ER16		± 1 mm	79	32
TC30RM20	1 ÷ 14	ER20		± 1 mm	85	35
TC30RM25	1 ÷ 20	ER25		± 1 mm	88	42
TC30RM32	2 ÷ 22	ER32		± 1.5 mm	93	50
TC30RM40	3 ÷ 30	ER40		± 1.5 mm	99	63
TC40RM11	1 ÷ 7	ER11	AD	± 1 mm	75	19
TC40RM16	1 ÷ 10	ER16		± 1 mm	79	32
TC40RM20	1 ÷ 14	ER20		± 1 mm	85	35
TC40RM25	1 ÷ 20	ER25		± 1 mm	88	42
TC40RM32	2 ÷ 22	ER32		± 1.5 mm	93	50
TC40RM40	3 ÷ 30	ER40		± 1.5 mm	99	63
TC50RM11	1 ÷ 7	ER11	AD	± 1 mm	84	19
TC50RM16	1 ÷ 10	ER16		± 1 mm	88	32
TC50RM20	1 ÷ 14	ER20		± 1 mm	94	35
TC50RM25	1 ÷ 20	ER25		± 1 mm	97	42
TC50RM32	2 ÷ 22	ER32		± 1.5 mm	102	50
TC50RM40	3 ÷ 30	ER40		± 1.5 mm	108	63

El escariador oscila radialmente con un sistema flotante y autocentrante regulable.

Se garantiza un perfecto alineamiento entre la herramienta y la pieza a mecanizar.

Está taladrado para permitir el paso de la refrigeración a través de la pinza o escariador.

*The holder is designed with full floating and self centering movement.*

*The alignment of the reamer with a previously drilled hole is granted also to the high speeds.*

*The floating of the reamer is easy adjustable.*

*The holder is full drilled for coolant or air supply y through the collet slots or the reamer holes.*



DIN/69871

Porta fresas weldon DIN 1835-B  
End mill holders for DIN 1835-B

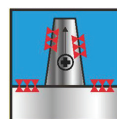
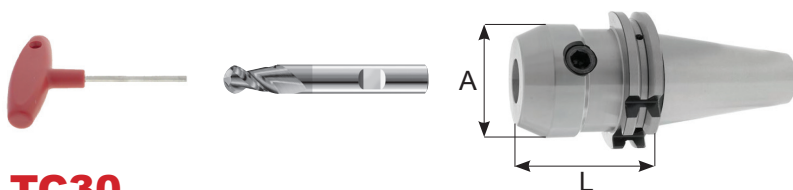

100% contact

\* G2.5 / 25.000rpm  
G6.3 / 15.000rpm  
Face contact

## TC30

REFERENCIA	D	RPM	FORMA	L	A
TC30L50WE6	6	15.000	AD	50	25
TC30L100WE6				100	
TC30L50WE8	8			50	28
TC30L100WE8				100	
TC30L50WE10	10			50	35
TC30L100WE10				100	
TC30L50WE12	12			50	42
TC30L100WE12				100	
TC30L50WE14	14			50	44
TC30L100WE14				100	
TC30L63WE16	16			63	48
TC30L100WE16				100	
TC30L63WE18	18	63	50		
TC30L100WE18		100			
TC30L63WE20	20	63	52		
TC30L100WE20		100			

## TC40

REFERENCIA	D	RPM	FORMA	L	A
TCB40L50WE6 *	6	15.000	AD+B	50	25
TCB40L100WE6				100	
TCB40L130WE6				130	
TCB40L160WE6				160	
TCB40L200WE6				200	
TCB40L50WE8 *	8	15.000	AD+B	50	28
TCB40L100WE8				100	
TCB40L130WE8				130	
TCB40L160WE8				160	
TCB40L200WE8				200	
TCB40L50WE10 *	10	15.000	AD+B	63	35
TCB40L100WE10				100	
TCB40L130WE10				130	
TCB40L160WE10				160	
TCB40L200WE10				200	

\* "Face contact" + "D" (DTCB40L50WE6)

Whistle-Notch on request.

TC40 →

DIN/69871

Porta fresas weldon DIN 1835-B  
End mill holders for DIN 1835-B

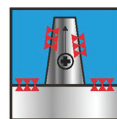
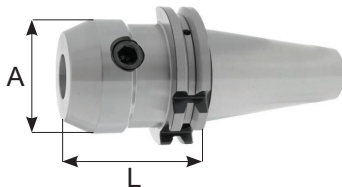
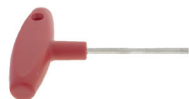

100% contact

\*

G2.5 / 25.000rpm  
G6.3 / 15.000rpm  
Face contact

**TC40**

REFERENCIA	D	RPM	FORMA	L	A
TCB40L50WE12 *	12	15.000	AD+B	50	42
TCB40L100WE12				100	
TCB40L130WE12				130	
TCB40L160WE12				160	
TCB40L200WE12				200	
TCB40L50WE14	14	15.000	AD+B	50	44
TCB40L100WE14				100	
TCB40L130WE14				130	
TCB40L160WE14				160	
TCB40L200WE14				200	
TCB40L63WE16 *	16	15.000	AD+B	63	48
TCB40L100WE16				100	
TCB40L130WE16				130	
TCB40L160WE16				160	
TCB40L200WE16				200	
TCB40L63WE18	18	15.000	AD+B	63	50
TCB40L100WE18				100	
TCB40L130WE18				130	
TCB40L160WE18				160	
TCB40L200WE18				200	
TCB40L63WE20 *	20	15.000	AD+B	63	52
TCB40L100WE20				100	
TCB40L130WE20				130	
TCB40L160WE20				160	
TCB40L200WE20				200	
TCB40L100WE25 *	25	15.000	AD+B	100	65
TCB40L130WE25				130	
TCB40L160WE25				160	
TCB40L100WE32 *	32	15.000	AD+B	100	72
TCB40L130WE32				130	
TCB40L160WE32				160	
TCB40L120WE40	40	15.000	AD+B	120	80

\* "Face contact" + "D" (DTCB40L50WE12)

Whistle-Notch on request.

**TC50** →

7

DIN/69871

Porta fresas weldon DIN 1835-B  
End mill holders for DIN 1835-B

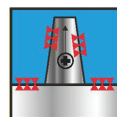
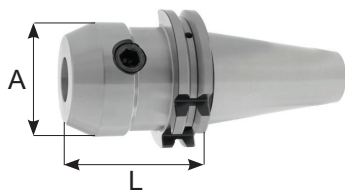
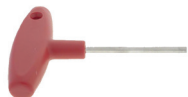

100% contact

\* G2.5 / 25.000rpm  
G6.3 / 15.000rpm  
Face contact

**TC50**

REFERENCIA	D	RPM	FORMA	L	A
TCB50L63WE6 *	6	15.000	AD+B	63	25
TCB50L100WE6				100	
TCB50L130WE6				130	
TCB50L160WE6				160	
TCB50L200WE6				200	
TCB50L63WE8 *	8	15.000	AD+B	63	28
TCB50L100WE8				100	
TCB50L130WE8				130	
TCB50L160WE8				160	
TCB50L200WE8				200	
TCB50L63WE10 *	10	15.000	AD+B	63	35
TCB50L100WE10				100	
TCB50L130WE10				130	
TCB50L160WE10				160	
TCB50L200WE10				200	
TCB50L63WE12 *	12	15.000	AD+B	63	42
TCB50L100WE12				100	
TCB50L130WE12				130	
TCB50L160WE12				160	
TCB50L200WE12				200	
TCB50L63WE14	14	15.000	AD+B	63	44
TCB50L100WE14				100	
TCB50L130WE14				130	
TCB50L160WE14				160	
TCB50L200WE14				200	
TCB50L63WE16 *	16	15.000	AD+B	63	48
TCB50L100WE16				100	
TCB50L130WE16				130	
TCB50L160WE16				160	
TCB50L200WE16				200	

\* "Face contact" + "D" (DTCB50L63WE6)

Whistle-Notch on request.

**TC50** →



DIN/69871

Porta fresas weldon DIN 1835-B  
End mill holders for DIN 1835-B

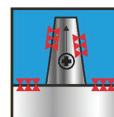
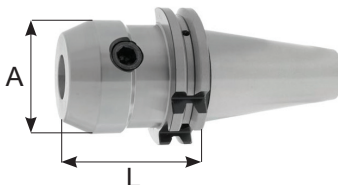
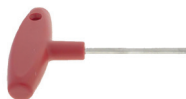

100% contact

TC50

\* G2.5 / 25.000rpm  
G6.3 / 15.000rpm  
Face contact

REFERENCIA	D	RPM	FORMA	L	A
TCB50L63WE18	18	15.000	AD+B	63	50
TCB50L100WE18				100	
TCB50L130WE18				130	
TCB50L160WE18				160	
TCB50L200WE18				200	
TCB50L63WE20 *	20	15.000	AD+B	63	52
TCB50L100WE20				100	
TCB50L130WE20				130	
TCB50L160WE20				160	
TCB50L200WE20				200	
TCB50L250WE20				250	
TCB50L80WE25 *	25	15.000	AD+B	80	65
TCB50L100WE25				100	
TCB50L130WE25				130	
TCB50L160WE25				160	
TCB50L200WE25				200	
TCB50L250WE25				250	
TCB50L100WE32 *	32	15.000	AD+B	100	72
TCB50L130WE32				130	
TCB50L160WE32				160	
TCB50L200WE32				200	
TCB50L250WE32				250	
TCB50L112WE40 *	40	15.000	AD+B	112	80
TCB50L130WE40				130	
TCB50L160WE40				160	
TCB50L200WE40				200	
TCB50L130WE50 *	50	15.000	AD+B	130	90

\* "Face contact" + "D" (DTCB50L63WE18)

Whistle-Notch on request.

7

DIN/69871

Porta fresas weldon con canal de refrigeración  
End mill holders with coolant channels



Coolant

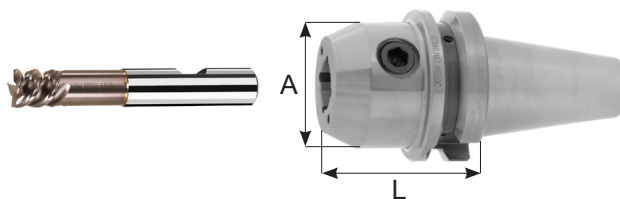

### TC40

REFERENCIA	D	RPM	FORMA	L	A
TCB40L65WE6C	6	15.000	AD+B	65	25
TCB40L65WE8C	8			65	28
TCB40L65WE10C	10			65	35
TCB40L65WE12C	12			65	42
TCB40L65WE14C	14			65	44
TCB40L65WE16C	16			65	48
TCB40L65WE18C	18			65	50
TCB40L65WE20C	20			65	52
TCB40L100WE25C	25			100	65
TCB40L100WE32C	32			100	72

### TC50

REFERENCIA	D	RPM	FORMA	L	A
TCB50L63WE6C	6	15.000	AD+B	63	25
TCB50L63WE8C	8			63	28
TCB50L63WE10C	10			63	35
TCB50L63WE12C	12			63	42
TCB50L63WE14C	14			63	44
TCB50L63WE16C	16			63	48
TCB50L63WE18C	18			63	50
TCB50L63WE20C	20			63	52
TCB50L100WE25C	25			100	65
TCB50L100WE32C	32			100	72
TCB50L100WE40C	40	100	90		

WE6 + WE14



WE16 + WE40

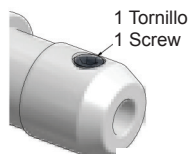
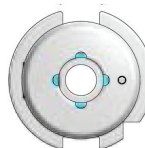

1 Tornillo  
1 Screw

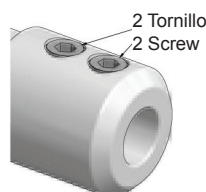

2 Tornillo  
2 Screw

DIN/69871

Porta fresas weldon extra corto DIN 1835-B  
Short type end mill holders for DIN 1835-B shanks

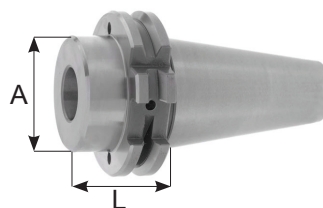
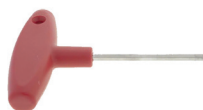

**TC30 / TC40 / TC50**

REFERENCIA	D	RPM	FORMA	L	A
TC30L35WE16	16	15.000	AD	35	32
TC30L35WE20	20			35	36
TCB40L35WE16	16	15.000	AD+B	35	44
TCB40L35WE20	20			35	44
TCB40L35WE25	25			35	44
TCB40L60WE25	25			60	50
TCB40L40WE32	32	15.000	AD+B	40	72
TCB40L70WE32	32			70	72
TCB50L35WE16	16	15.000	AD+B	35	70
TCB50L35WE20	20			35	70
TCB50L35WE25	25			35	70
TCB50L35WE32	32			35	70
TCB50L35WE40	32			35	70
TCB50L35WE40	40			35	80

7

DIN/69871

Porta fresas weldon regulación radial  
Radial adjustable end mill holders



+/- 0.01mm

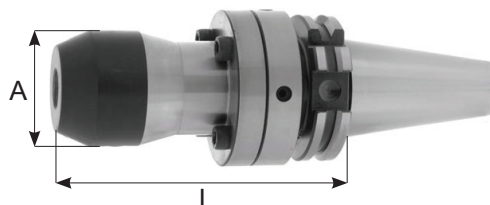

**TC40 / TC50**

REFERENCIA	D	FORMA	L	A
TCB40L100WE6RG	6	AD+B	100	25
TCB40L100WE8RG	8		100	28
TCB40L100WE10RG	10		100	35
TCB40L110WE12RG	12		110	42
TCB40L130WE16RG	16		130	48
TCB40L130WE18RG	18		130	50
TCB40L135WE20RG	20	135	52	
TCB50L100WE6RG	6	AD+B	100	25
TCB50L100WE8RG	8		100	28
TCB50L100WE10RG	10		100	35
TCB50L110WE12RG	12		110	42
TCB50L130WE16RG	16		130	48
TCB50L130WE18RG	18		130	50
TCB50L135WE20RG	20	135	52	

DIN/69871



Coolant

Porta fresas combinado con canal de refrigeración  
Combi shell end mill holders with coolant channels

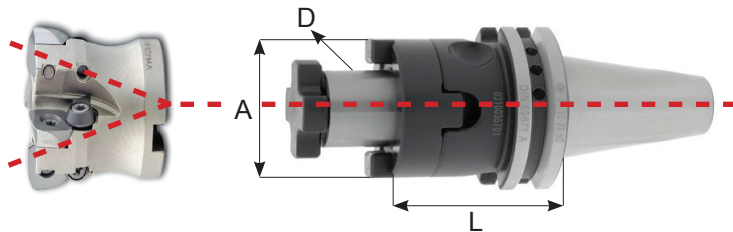

### TC30

REFERENCIA	D	RPM	FORMA	L	A
TC30L50D16C	16	15.000	AD	50	32
TC30L50D22C	22			50	40
TC30L55D27C	27			55	48
TC30L60D32C	32			60	58

### TC40

REFERENCIA	D	RPM	FORMA	L	A
TCB40L55D16C	16	15.000	AD+B	55	32
TCB40L100D16C				100	32
TCB40L130D16C				130	32
TCB40L160D16C				160	32
TCB40L200D16C				200	32
TCB40L55D22C	22	15.000	AD+B	55	40
TCB40L100D22C				100	40
TCB40L130D22C				130	40
TCB40L160D22C				160	40
TCB40L200D22C				200	40
TCB40L55D27C	27	15.000	AD+B	55	48
TCB40L100D27C				100	48
TCB40L130D27C				130	48
TCB40L160D27C				160	48
TCB40L200D27C				200	48
TCB40L60D32C	32	15.000	AD+B	60	58
TCB40L100D32C				100	58
TCB40L130D32C				130	58
TCB40L160D32C				160	58
TCB40L200D32C				200	58
TCB40L60D40C	40	15.000	AD+B	60	70
TCB40L100D40C				100	70
TCB40L130D40C				130	70
TCB40L160D40C				160	70
TCB40L200D40C				200	70

TC50 →

**DIN/69871**



**Porta fresas combinado con canal de refrigeración**  
*Combi shell end mill holders with coolant channels*

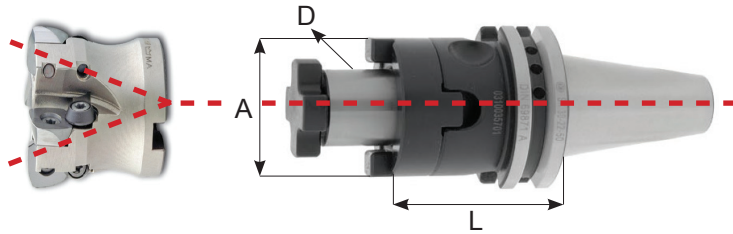

**TC50**

REFERENCIA	D	RPM	FORMA	L	A
TCB50L55D16C	16	15.000	AD+B	55	32
TCB50L100D16C				100	32
TCB50L130D16C				130	32
TCB50L160D16C				160	32
TCB50L55D22C	22	15.000	AD+B	55	40
TCB50L100D22C				100	40
TCB50L130D22C				130	40
TCB50L160D22C				160	40
TCB50L55D27C	27	15.000	AD+B	55	48
TCB50L100D27C				100	48
TCB50L130D27C				130	48
TCB50L160D27C				160	48
TCB50L55D32C	32	15.000	AD+B	55	58
TCB50L100D32C				100	58
TCB50L130D32C				130	58
TCB50L160D32C				160	58
TCB50L55D40C	40	15.000	AD+B	55	70
TCB50L100D40C				100	70
TCB50L130D40C				130	70
TCB50L160D40C				160	70



DIN/69871

Porta fresas fijo con canal de refrigeración  
Shell end mill holders with coolant channels



Coolant

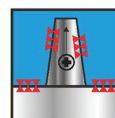
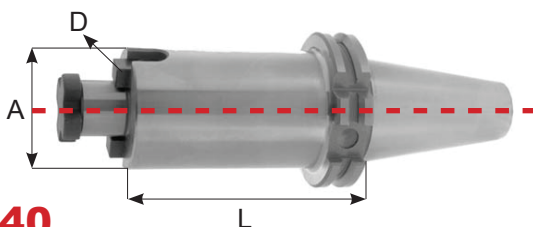

100% contact

\* G2.5 / 25.000rpm  
G6.3 / 15.000rpm  
Face contact

TC30 / TC40

REFERENCIA	D	RPM	FORMA	L	A
TC30L35D16S	16	15.000	AD	35	32
TC30L35D22S				35	40
TC30L60D27S				60	50
TC30L60D32S				60	58
TCB40L35D16S *	16	15.000	AD+B	35	38
TCB40L50D16S				50	38
TCB40L100D16S				100	38
TCB40L130D16S				130	38
TCB40L160D16S				160	38
TCB40L200D16S				200	38
TCB40L35D22S *	22	15.000	AD+B	35	48
TCB40L45D22S				45	48
TCB40L100D22S				100	48
TCB40L130D22S				130	48
TCB40L160D22S				160	48
TCB40L200D22S				200	48
TCB40L35D27S	27	15.000	AD+B	35	58
TCB40L50D27S *				50	58
TCB40L100D27S				100	58
TCB40L130D27S				130	58
TCB40L160D27S				160	58
TCB40L200D27S				200	58
TCB40L50D32S	32	15.000	AD+B	50	78
TCB40L55D32S *				55	78
TCB40L100D32S				100	78
TCB40L130D32S				130	78
TCB40L160D32S				160	78
TCB40L200D32S				200	78
TCB40L50D40S	40	15.000	AD+B	50	88
TCB40L60D40S *				60	88
TCB40L100D40S				100	88
TCB40L130D40S				130	88
TCB40L160D40S				160	88
TCB40L200D40S				200	88

\* "Face contact" + "D" (DTCB40L35D16S)

TC50 →

DIN/69871

Porta fresas fijo con canal de refrigeración  
Shell end mill holders with coolant channels

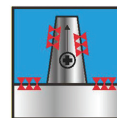
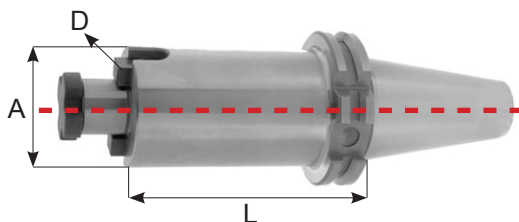

100% contact

\* G2.5 / 25.000rpm  
G6.3 / 15.000rpm  
Face contact

**TC50**

REFERENCIA	D	RPM	FORMA	L	A
TCB50L35D16S *	16	15.000	AD+B	35	38
TCB50L45D16S				45	38
TCB50L100D16S				100	38
TCB50L130D16S				130	38
TCB50L160D16S				160	38
TCB50L200D16S				200	38
TCB50L250D16S				250	38
TCB50L300D16S				300	38
TCB50L350D16S				350	38
TCB50L35D22S *	22	15.000	AD+B	35	48
TCB50L45D22S				45	48
TCB50L100D22S				100	48
TCB50L130D22S				130	48
TCB50L160D22S				160	48
TCB50L200D22S				200	48
TCB50L250D22S				250	48
TCB50L300D22S				300	48
TCB50L350D22S				350	48
TCB50L400D22S	400	48			
TCB50L35D27S *	27	15.000	AD+B	35	58
TCB50L45D27S				45	58
TCB50L100D27S				100	58
TCB50L130D27S				130	58
TCB50L160D27S				160	58
TCB50L200D27S				200	58
TCB50L250D27S				250	58
TCB50L300D27S				300	58
TCB50L350D27S				350	58
TCB50L400D27S	400	58			

\* "Face contact" + "D" (DBTB40L45D22S)

**TC50** →

DIN/69871

Porta fresas fijo con canal de refrigeración  
Shell end mill holders with coolant channels



Coolant

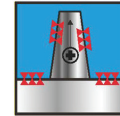
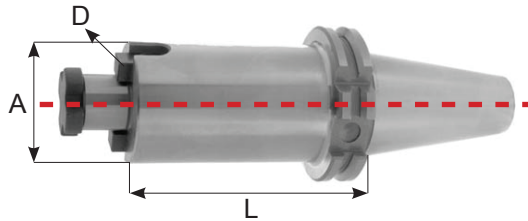

100% contact

\*

G2.5 / 25.000rpm  
G6.3 / 15.000rpm  
Face contact

TC50

REFERENCIA	D	RPM	FORMA	L	A
TCB50L35D32S *	32	15.000	AD+B	35	78
TCB50L50D32S				50	78
TCB50L100D32S				100	78
TCB50L130D32S				130	78
TCB50L160D32S				160	78
TCB50L200D32S				200	78
TCB50L250D32S				250	78
TCB50L300D32S				300	78
TCB50L350D32S				350	78
TCB50L35D40S	40	15.000	AD+B	35	88
TCB50L50D40S *				50	88
TCB50L100D40S				100	88
TCB50L130D40S				130	88
TCB50L160D40S				160	88
TCB50L200D40S				200	88

\* "Face contact" + "D" (DBTB40L45D22S)

DIN/69871

Porta herramientas para mango roscado DIN/6327  
Holders for adjustable adapters DIN/6327

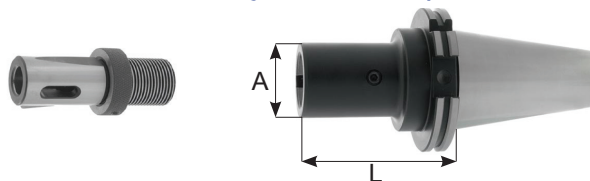

TC40 / TC50

REFERENCIA	TR	FORMA	L	A
TC40L75TR16	16	AD	75	25
TC40L80TR20	20		80	32
TC40L100TR28	28		100	40
TC40L115TR36	36		115	50
TC50L85TR16	16	AD	85	25
TC50L85TR20	20		85	32
TC50L100TR28	28		100	40
TC50L100TR36	36		100	50
TC50L105TR48	48		105	67



DIN/69871

Porta fresas fijo antivibratorio conicidad DIN/138  
Antivibratory shell mill adaptors DIN/138



### TC40

### ANTIVIBRATORIO

REFERENCIA	D	L	A	B
TC40L150D16AV	16	150	38	50
TC40L200D16AV		200		
TC40L250D16AV		250		
TC40L300D16AV		300		
TC40L150D22AV	22	150	48	50
TC40L200D22AV		200		
TC40L250D22AV		250		
TC40L300D22AV		300		

### TC50

REFERENCIA	D	L	A	B
TC50L150D16AV	16	150	38	80
TC50L200D16AV		200		
TC50L250D16AV		250		
TC50L300D16AV		300		
TC50L400D16AV		400		
TC50L200D22AV	22	200	48	80
TC50L250D22AV		250		
TC50L300D22AV		300		
TC50L400D22AV		400		
TC50L500D22AV		500		
TC50L200D27AV	27	200	58	80
TC50L250D27AV		250		
TC50L300D27AV		300		
TC50L400D27AV		400		
TC50L500D27AV		500		

Especial para moldistas y troquelistas, reduce las vibraciones en un 60% comparandolo con un porta standard.

Special for mould and die makers, vibration reduced up to 60% compared to any other conventional shell mill adaptor.

7

DIN/69871

Porta fresas fijo antivibratorio DIN/138  
Antivibratory shell mill adaptors DIN/138



## TC40

ANTIVIBRATORIO

REFERENCIA	D	L	A
TC40L150D16AV-38	16	150	38
TC40L200D16AV-38		200	
TC40L250D16AV-38		250	
TC40L300D16AV-38		300	
TC40L150D22AV-48	22	150	48
TC40L200D22AV-48		200	
TC40L250D22AV-48		250	
TC40L300D22AV-48		300	
TC40L150D27AV-58	27	150	58
TC40L200D27AV-58		200	
TC40L250D27AV-58		250	
TC40L300D27AV-58		300	

## TC50

REFERENCIA	D	L	A
TC50L150D16AV-38	16	150	38
TC50L200D16AV-38		200	
TC50L250D16AV-38		250	
TC50L300D16AV-38		300	
TC50L400D16AV-38		400	
TC50L200D22AV-48	22	200	48
TC50L250D22AV-48		250	
TC50L300D22AV-48		300	
TC50L400D22AV-48		400	
TC50L500D22AV-48		500	
TC50L200D22AV-60	22	200	60
TC50L250D22AV-60		250	
TC50L300D22AV-60		300	
TC50L400D22AV-60		400	
TC50L500D22AV-60		500	

Especial para moldistas y troquelistas, reduce las vibraciones en un 60% comparandolo con un porta standard.  
Special for mould and die makers, vibration reduced up to 60% compared to any other conventional shell mill adaptor.

**TC50** →

DIN/69871

Porta fresas fijo antivibratorio DIN/138  
Antivibratory shell mill adaptors DIN/138

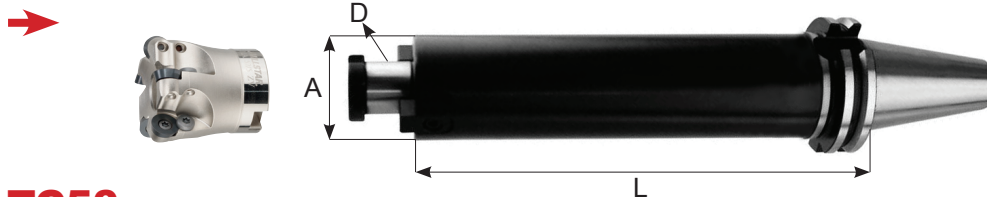

TC50

ANTIVIBRATORIO

REFERENCIA	D	L	A
TC50L200D27AV-58	27	200	58
TC50L250D27AV-58		250	
TC50L300D27AV-58		300	
TC50L400D27AV-58		400	
TC50L500D27AV-58		500	
TC50L200D32AV-78	32	200	78
TC50L250D32AV-78		250	
TC50L300D32AV-78		300	
TC50L400D32AV-78		400	
TC50L500D32AV-78		500	

Especial para moldistas y troquelistas, reduce las vibraciones en un 60% comparandolo con un porta standard.  
Special for mould and die makers, vibration reduced up to 60% compared to any other conventional shell mill adaptor.

DIN/69871

Porta fresas fijo antivibratorio DIN/138 con refrigeración  
Antivibratory shell mill adaptors DIN/138 coolant



TC40 / TC50

ANTIVIBRATORIO

REFERENCIA	D	FORMA	L	A
TC40L200D16AV-38R	16	AD	200	38
TC40L300D16AV-38R	16		300	38
TC40L200D22AV-48R	22		200	48
TC40L300D22AV-48R	22		300	48
TC40L200D27AV-58R	27		200	58
TC50L200D16AV-38R	16	AD	200	38
TC50L300D16AV-38R	16		300	38
TC50L200D22AV-48R	22		200	48
TC50L300D22AV-48R	22		300	48
TC50L200D27AV-58R	27		200	58
TC50L300D27AV-58R	27		300	58
TC50L300D32AV-78R	32		300	78

DIN/69871

Porta herramientas para fresa roscada  
Tool holder for screwed milling cutters

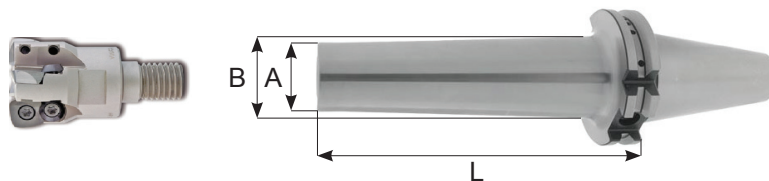

TC40 / TC50

REFERENCIA	M	RPM	FORMA	L	A	B
TCB40L44M6CPY	M6	25.000	AD+B	44	10	13
TCB40L69M6CPY				69		20
TCB40L94M6CPY				94		23
TCB40L55M8CPY	M8	25.000	AD+B	55	13	15
TCB40L75M8CPY				75		23
TCB40L95M8CPY				95		23
TCB40L115M8CPY	M10	25.000	AD+B	115	18	25
TCB40L55M10CPY				55		20
TCB40L75M10CPY				75		25
TCB40L95M10CPY	M12	25.000	AD+B	95	21	28
TCB40L105M10CPY				105		28
TCB40L145M10CPY				145		34
TCB40L55M12CPY	M16	25.000	AD+B	55	29	24
TCB40L75M12CPY				75		24
TCB40L95M12CPY				95		31
TCB40L115M12CPY	M8	25.000	AD+B	115	13	31
TCB40L145M12CPY				145		38
TCB40L175M12CPY				175		42
TCB40L55M16CPY	M10	25.000	AD+B	55	18	34
TCB40L75M16CPY				75		34
TCB40L95M16CPY				95		34
TCB40L115M16CPY	M12	25.000	AD+B	115	21	39
TCB40L145M16CPY				145		39
TCB40L175M16CPY				175		39
TCB50L69M8CPY	M8	25.000	AD+B	69	13	23
TCB50L119M8CPY				119		25
TCB50L169M8CPY				169		30
TCB50L85M10CPY	M10	25.000	AD+B	85	18	23
TCB50L135M10CPY				135		32
TCB50L185M10CPY				185		36.5
TCB50L85M12CPY	M12	25.000	AD+B	85	21	24
TCB50L135M12CPY				135		33
TCB50L185M12CPY				185		40
TCB50L85M16CPY	M16	25.000	AD+B	85	29	34
TCB50L135M16CPY				135		36
TCB50L185M16CPY				185		42.5

DIN/69871

Porta herramientas para fresa roscada antivibratorio  
 Antivibratory for frontal end mills support screwed shanks

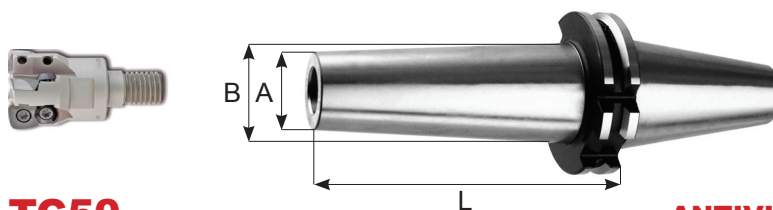

**TC40 / TC50**

**ANTIVIBRATORIO**

REFERENCIA	M	L	A	B
TC40L200M10AV	M10	200	18	35
TC40L250M10AV		250		41
TC40L300M10AV		300		46
TC40L200M12AV	M12	200	21	38
TC40L250M12AV		250		44
TC40L300M12AV		300		49
TC40L200M16AV	M16	200	29	46
TC40L250M16AV		250		48
TC40L300M16AV		300		50
TC50L250M12AV	M12	250	21	44
TC50L300M12AV		300		49
TC50L400M12AV		400		60
TC50L250M16AV	M16	250	29	52
TC50L300M16AV		300		57
TC50L400M16AV		400		68
TC50L500M16AV		500		78

Porta herramientas para fresa roscada antivibratorio refrigerante  
 Antivibratory for frontal end mills support screwed shanks coolant

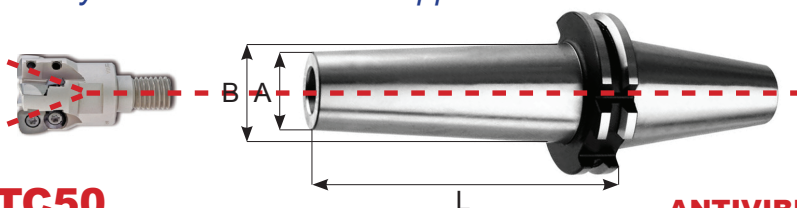

**TC40 / TC50**

**ANTIVIBRATORIO**

REFERENCIA	M	FORMA	L	A	B
TC40L200M10AVR	M10	AD	200	18	35
TC40L250M10AVR	M10		250	18	41
TC40L200M12AVR	M12		200	21	38
TC40L250M12AVR	M12		250	21	44
TC40L250M16AVR	M16		250	29	48
TC50L300M12AVR	M12	AD	300	21	49
TC50L300M16AVR	M16		300	29	57

Especial para moldistas y troquelistas, reduce las vibraciones en un 60% comparandolo con un porta standard.  
 Special for mould and die makers, vibration reduced up to 60% compared to any other conventional shell mill adaptor.

DIN/69871

Reductor cono morse DIN/228-B  
Morse taper adapters DIN/228-B

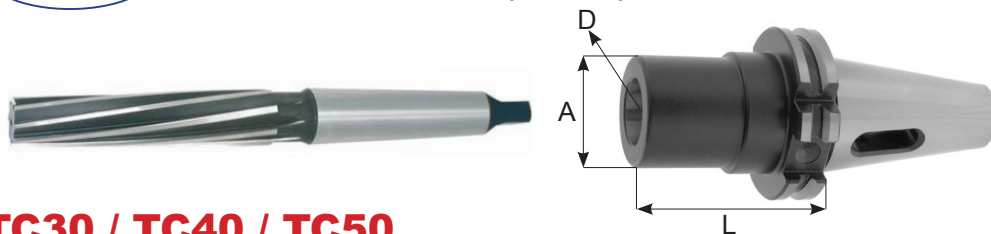

**TC30 / TC40 / TC50**

REFERENCIA	D	FORMA	L	A
TC30L50CM1P	CM1	AD	50	25
TC30L65CM2P	CM2		65	32
TC30L80CM3P	CM3		80	40
TCB40L50CM1P	CM1	AD+B	50	25
TCB40L50CM2P	CM2		50	32
TCB40L70CM3P	CM3		70	40
TCB40L95CM4P	CM4		95	48
TCB50L45CM1P	CM1	AD+B	45	25
TCB50L60CM2P	CM2		60	32
TCB50L65CM3P	CM3		65	40
TCB50L95CM4P	CM4		95	48
TCB50L105CM5P	CM5		105	63

Reductor cono morse DIN/228-A con tornillo tirante  
Reducing adaptors morse taper shank and drawbar thread DIN/228-A

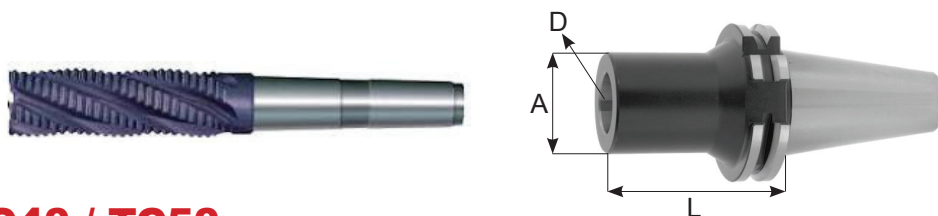

**TC40 / TC50**

REFERENCIA	D	FORMA	L	A
TC40L50CM1F	CM1	AD	50	25
TC40L50CM2F	CM2		50	32
TC40L70CM3F	CM3		70	40
TC40L95CM4F	CM4		95	48
TC50L45CM1F	CM1	AD	45	25
TC50L60CM2F	CM2		60	32
TC50L65CM3F	CM2		65	40
TC50L70CM4F	CM2		70	48
TC50L85CM4F	CM3		85	48
TC50L100CM4F	CM4		100	63
TC50L118CM5F	CM5		118	63

DIN/69871

Reductor TC a ISO DIN/2080 - DIN/69871  
Reducing adaptors TC a ISO DIN/2080 - DIN/69871

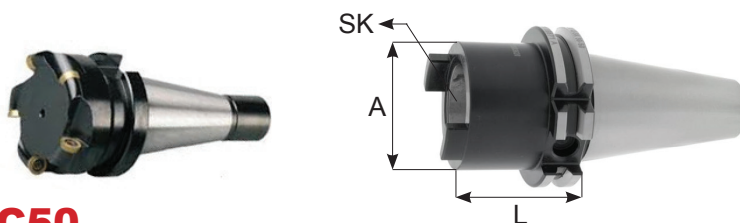

TC40 / TC50

REFERENCIA	ISO	FORMA	L	A
TC40L60TB30	TC30	AD	60	50
TC40L95TB40	TC40		95	70
TC40L60ISO30	ISO30	AD	60	50
TC40L95ISO40	ISO40		95	70
TC50L70TB40	TC40	AD	70	70
TC50L120TB50	TC50		120	90
TC50L70ISO40	ISO40	AD	70	70
TC50L120ISO50	ISO50		120	90

7

DIN/69871

Cono reductor DIN/69871 a HSK - A/C/E/F con RACOR  
Adaptors DIN/69871 shank to HSK - A/C/E/F with cooling tube

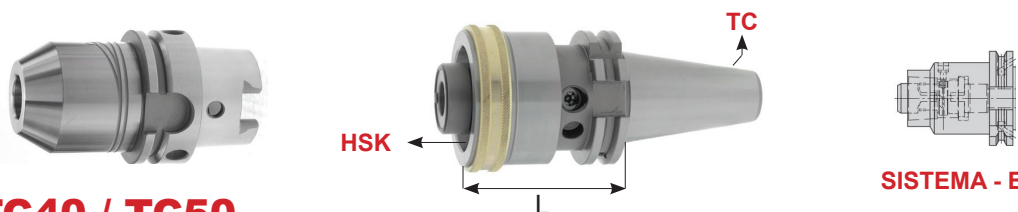

TC40 / TC50

REFERENCIA	CONO	FORMA	REDUCTOR	L
TC40BL45HSK25	TC40	AD	HSK25-A/C/E/F	45
TC40BL55HSK32			HSK32-A/C/E/F	55
TC40BL75HSK40			HSK40-A/C/E/F	75
TC40BL95HSK50			HSK50-A/C/E/F	95
TC40BL110HSK63			HSK63-A/C/E/F	110
TC40BL150HSK80			HSK80-A/C/E/F	150
TC40BL150HSK100			HSK100-A/C/E/F	150
TC50BL75HSK32	TC50	AD	HSK32-A/C/E/F	75
TC50BL75HSK40			HSK40-A/C/E/F	75
TC50BL75HSK50			HSK50-A/C/E/F	75
TC50BL75HSK63			HSK63-A/C/E/F	75
TC50BL100HSK80			HSK80-A/C/E/F	100
TC50BL150HSK100			HSK100-A/C/E/F	150

**Cono reductor DIN/69871 a HSK - A/C con Pistón de tensar y junta**  
*Adapters DIN/69871 shank to HSK - A/C with tensioning piston and gasket*

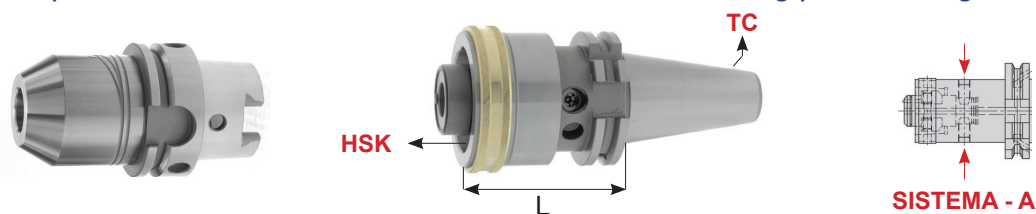

**TC30 / TC40 / TC50**

REFERENCIA	CONO	FORMA	REDUCTOR	L
TC30BL55HSK32AC	TC30	AD	HSK32-A/C	55
TC30BL60HSK40AC			HSK40-A/C	60
TC30BL75HSK50AC			HSK50-A/C	75
TC40BL55HSK25AC	TC40	AD	HSK25-A/C	55
TC40BL55HSK32AC			HSK32-A/C	55
TC40BL60HSK40AC			HSK40-A/C	60
TC40BL65HSK50AC			HSK50-A/C	65
TC40BL75HSK63AC			HSK63-A/C	75
TC40BL105HSK80AC			HSK80-A/C	105
TC40BL110HSK100AC			HSK100-A/C	110
TC0BL50HSK25AC	TC50	AD	HSK25-A/C	50
TC50BL55HSK32AC			HSK32-A/C	55
TC50BL60HSK40AC			HSK40-A/C	60
TC50BL65HSK50AC			HSK50-A/C	65
TC50BL75HSK63AC			HSK63-A/C	75
TC50BL120HSK63AC			HSK63-A/C	120
TC50BL150HSK63AC			HSK63-A/C	150
TC50BL500HSK63AC			HSK63-A/C	500
TC50BL80HSK80AC			HSK80-A/C	80
TC50BL100HSK100AC			HSK100-A/C	100
TC50BL140HSK125AC			HSK125-A/C	140
TC50BL160HSK160AC			HSK160-A/C	160





DIN/69871

**Cono Reductor de TC a PSC - ISO 26623-1**  
Adapters from TC shank to PSC - ISO 26623-1

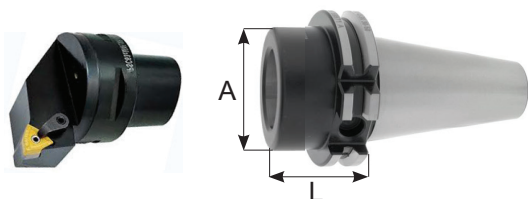

PSC-ECA ISO 26623-1

**TCB-C3**

REFERENCIA	CONO	REDUCTOR	FORMA	L	A
TCB30L30C3	TC30	PSC-C3	AD+B	30	32
TCB30L60C3	TC30	PSC-C3		60	32
TCB40L30C3	TC40	PSC-C3		30	32
TCB40L60C3	TC40	PSC-C3		60	32
TCB50L40C3	TC50	PSC-C3		30	32
TCB50L70C3	TC50	PSC-C3		60	32

**TCB-C4**

REFERENCIA	CONO	REDUCTOR	FORMA	L	A
TCB40L30C4	TC40	PSC-C4	AD+B	30	40
TCB40L60C4	TC40	PSC-C4		60	40
TCB50L40C4	TC50	PSC-C4		30	40
TCB50L70C4	TC50	PSC-C4		60	40

**TCB-C5**

REFERENCIA	CONO	REDUCTOR	FORMA	L	A
TCB40L30C5	TC40	PSC-C5	AD+B	30	50
TCB40L70C5	TC40	PSC-C5		70	50
TCB50L40C5	TC50	PSC-C5		30	50
TCB50L80C5	TC50	PSC-C5		70	50

**TCB-C6**

REFERENCIA	CONO	REDUCTOR	FORMA	L	A
TCB40L85C6	TC40	PSC-C6	AD+B	85	63
TCB50L30C6	TC50	PSC-C6		30	63
TCB50L80C6	TC50	PSC-C6		80	63

**TCB-C8**

REFERENCIA	CONO	REDUCTOR	FORMA	L	A
TCB50L70C8	TC50	PSC-C8	AD+B	70	80
TCB50L120C8	TC50	PSC-C8		120	80

7

DIN/69871

Rosgador con compresión y tracción  
Tension and compression tap holders-

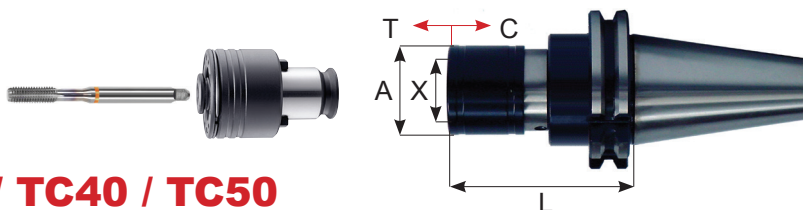

TC30 / TC40 / TC50

REFERENCE	CAP	X	A	L	C	T
TC30-THTC0-L72	M 1 ÷ M10	13	26	72	6.5	6.5
TC40-THTC0-L72				72		
TC50-THTC0-L72				72		
TC30-THTC1-L75	M 3 ÷ M18	19	36	75	7.5	7.5
TC40-THTC1-L75				75		
TC50-THTC1-L75				75		
TC30-THTC2-L98	M 8 ÷ M30	31	53	98	12.5	12.5
TC40-THTC2-L98				98		
TC50-THTC2-L98				98		
TC40-THTC3-L165	M14 ÷ M48	48	78	165	20.0	20.0
TC50-THTC3-L160				160		
TC50-THTC4-L161	M22 ÷ M60	60	96	161	22.5	22.5

DIN/69871

Rosgador Rígido  
Rigid tap holders

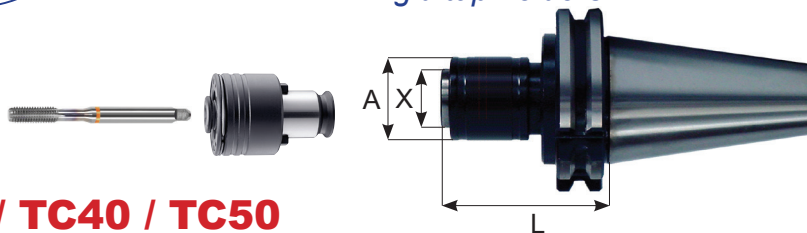

TC30 / TC40 / TC50

REFERENCE	CAP	X	A	L
TC30-TLR0-L72	M 1 ÷ M10	13	26	72
TC40-TLR0-L72				72
TC30-TLR1-L72	M 3 ÷ M18	19	36	72
TC40-TLR1-L72				72
TC50-TLR1-L72				72
TC40-TLR2-L91	M 8 ÷ M30	31	53	91
TC50-TLR2-L91				91
TC40-TLR3-L123	M14 ÷ M48	48	78	123
TC50-TLR3-L118				118

**DIN/69871**

Roscador con compresión y tracción con paso refrigerante  
*Tension and compression tap holders with coolant thru*

Coolant  
**SES**  
 Refrigeración Central

**SYNCHRO**

**Max. 50 BAR**

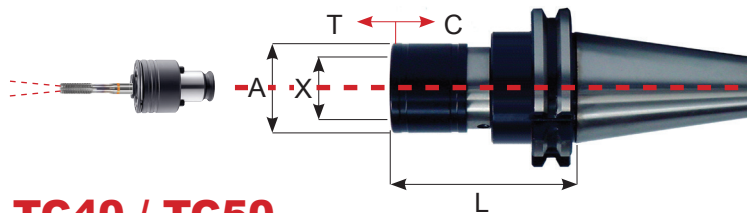

Refrigeración Interna  
 Coolant flow

**TC30 / TC40 / TC50**

REFERENCE	CAP	FORMA	X	A	L	MODELO
TC30-THTC0-L62C	M 1 ÷ M10	AD	13	26	62	<b>SYNCHRO</b>
TC40-THTC0-L62C					62	
TC50-THTC0-L62C					62	
TC30-THTC1-L81C	M 3 ÷ M18	AD	19	36	81	<b>SYNCHRO</b>
TC40-THTC1-L81C					81	
TC50-THTC1-L81C					81	
TC40-THTC2-L109C	M 8 ÷ M30	AD	31	53	109	<b>SYNCHRO</b>
TC50-THTC2-L109C					109	
TC40-THTC3-L147C	M22 ÷ M60	AD	60	96	147	<b>SYNCHRO</b>
TC50-THTC3-L142C					142	



DIN/69871

Roscador synchro con compresión y tracción  
con paso refrigerante

Synchro - Tension / Compression Tap Holders collet ER  
coolant flow

# SYNCHRO

Max. 50 BAR



Coolant

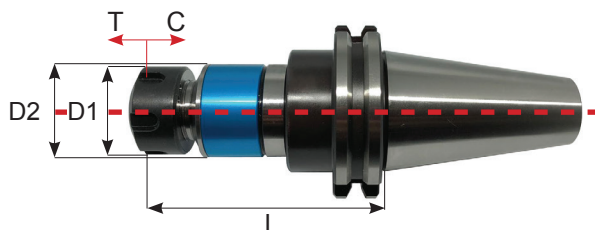

Refrigeración  
Interna  
Coolant flow

Coolant flow

(A)



RG

HT / HTE

ERXGM



Standard

(B)



GS

ERXM



## TC30 / TC40 / TC50

REFERENCE	CAP	FORMA	COLLET	D1	D2	L	C	T
TC30L79SYER16M	3 ÷ 8	AD	ER-16M	22	34	79	0.5	0.5
TC30L79SYER16	3 ÷ 8		ER-16	32	34	79		
TC40L79SYER16M	3 ÷ 8	AD	ER-16M	22	34	79	0.5	0.5
TC40L79SYER16	3 ÷ 8		ER-16	32	34	79		
TC40L80SYER20	3 ÷ 16		ER-20	35	34	80		
TC40L84SYER25	3 ÷ 20		ER-25	42	45	84		
TC40L95SYER32	3 ÷ 27		ER-32	50	45	95		
TC40L120SYER16	3 ÷ 27		ER-40	63	62	120		
TC50L79SYER16M	3 ÷ 8	AD	ER-16M	22	34	79	0.5	0.5
TC50L79SYER16	3 ÷ 8		ER-16	32	34	79		
TC50L80SYER20	3 ÷ 16		ER-20	35	34	80		
TC50L84SYER16	3 ÷ 20		ER-25	42	45	84		
TC50L95SYER16	3 ÷ 27		ER-32	50	45	95		
TC50L105SYER16	3 ÷ 27		ER-40	63	62	105		

DIN/69871

Roscador con compresión y tracción pinza ER  
Tension and compression tap holders collet ER

COMPRESION / TRACCION

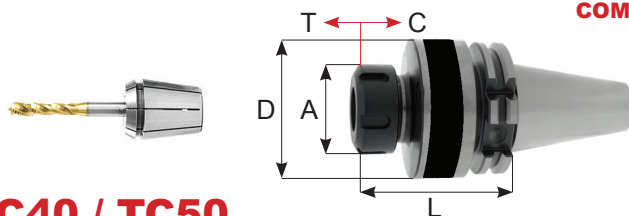

TC30 / TC40 / TC50

REFERENCIA	PINZA	L	A	D	C	T
TC30CTL83ER16	ER16	83	32	29	2.5	5.5
TC30CTL94ER20	ER20	94	35	44	3	9
TC30CTL103ER25	ER25	103	42	58	3	9
TC40CTL83ER16	ER16	83	32	29	2.5	5.5
TC40CTL94ER20	ER20	94	35	44	3	9
TC40CTL103ER25	ER25	103	42	58	3	9
TC40CTL105ER32	ER32	105	50	58	4	12
TC50CTL83ER16	ER16	83	32	29	2.5	5.5
TC50CTL94ER20	ER20	94	35	44	3	9
TC50CTL103ER25	ER25	103	42	58	3	9
TC50CTL105ER32	ER32	105	50	48	4	12

7

DIN/69871

Roscador solo tracción pinza ER  
Tension and compression tap holders collet ER

SOLO TRACCION

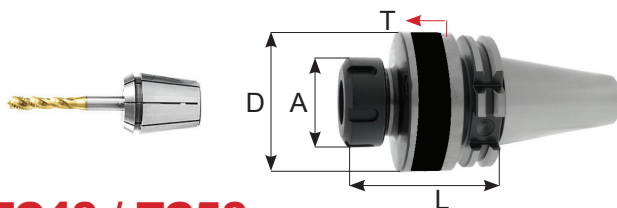

TC30 / TC40 / TC50

REFERENCIA	PINZA	L	A	D	T
TC30TL83ER16	ER16	83	32	29	8
TC30TL94ER20	ER20	94	35	44	12
TC30TL103ER25	ER25	103	42	58	12
TC40TL83ER16	ER16	83	32	29	8
TC40TL94ER20	ER20	94	35	44	12
TC40TL103ER25	ER25	103	42	58	16
TC40TL105ER32	ER32	105	50	58	16
TC50TL83ER16	ER16	83	32	29	8
TC50TL94ER20	ER20	94	35	44	12
TC50TL103ER25	ER25	103	42	58	16
TC50TL105ER32	ER32	105	50	58	16

DIN/69871

Porta herramientas inducción Térmica  
Shrink Fit holders

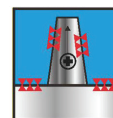
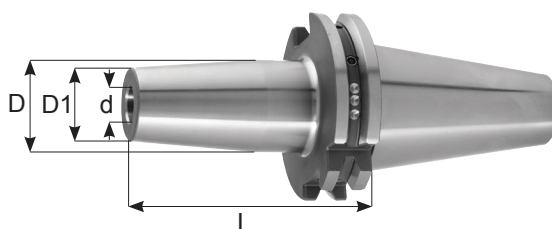

100%  
contact

\* G2.5 / 25.000rpm  
G6.3 / 15.000rpm  
Face contact

TC30 / TC40

REFERENCIA	d	RPM	FORMA	D1	D	L	
TC30L80CL3	3	25.000	AD	10	20	80	
TC30L80CL4	4			15	24	80	
TC30L80CL5	5			15	24	80	
TC30L80CL6	6			20	27	80	
TC30L80CL8	8			20	27	80	
TC30L80CL10	10			24	31	80	
TC30L80CL12	12			24	31	80	
TC30L80CL14	14			27	34	80	
TC30L80CL16	16			27	34	80	
TC30L80CL18	18			33	40	90	
TC30L80CL20	20		33	40	90		
TCB40L80CL3 *	3		25.000	AD+B	10	20	80
TCB40L120CL3	3				10	20	120
TCB40L160CL3	3				10	20	160
TCB40L80CL4 *	4				15	22	80
TCB40L120CL4	4				15	22	120
TCB40L160CL4	4				15	22	160
TCB40L80CL5 *	5				15	22	80
TCB40L120CL5	5				15	22	120
TCB40L160CL5	5				15	22	160
TCB40L80CL6 *	6	21			27	80	
TCB40L130CL6	6	21		27	130		
TCB40L160CL6	6	21		27	160		
TCB40L80CL8 *	8	21		27	80		
TCB40L130CL8	8	21		27	130		
TCB40L160CL8	8	21		27	160		
TCB40L80CL10 *	10	24		32	80		
TCB40L130CL10	10	24		32	130		
TCB40L160CL10	10	24		32	160		
TCB40L80CL12 *	12	24		32	80		
TCB40L130CL12	12	24		32	130		
TCB40L160CL12	12	24	32	160			
TCB40L80CL14 *	14	27	34	80			
TCB40L130CL14	14	27	34	130			
TCB40L160CL14	14	27	34	160			

\* "Face contact" + "D" (DTCB40L80CL3)

TC40 / TC50 →

DIN/69871

Porta herramientas Inducción Térmica  
Shrink Fit holders



on request

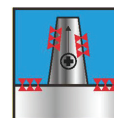
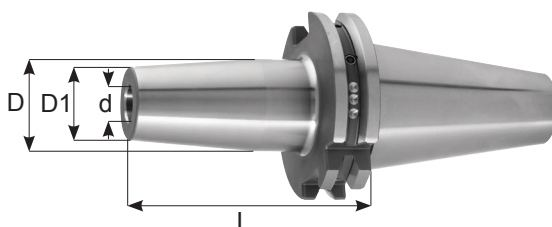

100% contact

\* G2.5 / 25.000rpm  
G6.3 / 15.000rpm  
Face contact

TC40 / TC50

REFERENCIA	d	RPM	FORMA	D1	D	L		
TCB40L80CL16 *	16	25.000	AD+B	27	34	80		
TCB40L130CL16	16			27	34	130		
TCB40L160CL16	16			27	34	160		
TCB40L80CL18 *	18			33	42	80		
TCB40L130CL18	18			33	42	130		
TCB40L160CL18	18			33	42	160		
TCB40L80CL20 *	20			33	42	80		
TCB40L130CL20	20			33	42	130		
TCB40L160CL20	20			33	42	160		
TCB40L100CL25 *	25			44	44	100		
TCB40L130CL25	25			44	44	130		
TCB40L160CL25	25			44	44	160		
TCB40L100CL32 *	32			44	44	100		
TCB40L130CL32	32			44	44	130		
TCB40L160CL32	32			44	44	160		
TCB50L80CL3 *	3			25.000	AD+B	10	20	80
TCB50L120CL3	3					10	20	120
TCB50L160CL3	3					10	20	160
TCB50L80CL4 *	4					15	25	80
TCB50L120CL4	4					15	22	120
TCB50L160CL4	4	15	22			160		
TCB50L80CL5 *	5	15	25			80		
TCB50L120CL5	5	15	22			120		
TCB50L160CL5	5	15	22			160		
TCB50L80CL6 *	6	20	27			80		
TCB50L120CL6	6	20	27			120		
TCB50L160CL6	6	20	27			160		
TCB50L80CL8 *	8	20	27			80		
TCB50L120CL8	8	20	27			120		
TCB50L160CL8	8	20	27			160		
TCB50L80CL10 *	10	24	31			80		
TCB50L120CL10	10	24	31			120		
TCB50L160CL10	10	24	31			160		
TCB50L80CL12 *	12	24	31			80		
TCB50L120CL12	12	24	31			120		
TCB50L160CL12	12	24	31	160				

\* "Face contact" + "D" (DTCB40L80CL18)

TC50 →

DIN/69871

Porta herramientas inducción térmica  
Shrink Fit holders

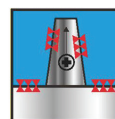
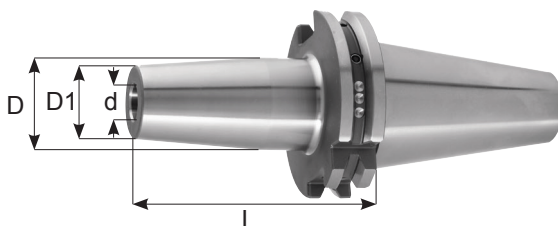
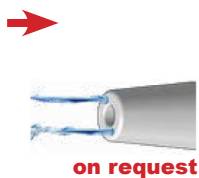

100% contact

\* G2.5 / 25.000rpm  
G6.3 / 15.000rpm  
Face contact

TC50

REFERENCIA	d	RPM	FORMA	D1	D	L
TCB50L80CL14 *	14	25.000	AD+B	27	34	80
TCB50L120CL14	14			27	34	120
TCB50L160CL14	14			27	34	160
TCB50L80CL16 *	16			27	34	80
TCB50L120CL16	16			27	34	120
TCB50L160CL16	16			27	34	160
TCB50L80CL14 *	14			27	34	80
TCB50L120CL14	14			27	34	120
TCB50L160CL14	14			27	34	160
TCB50L80CL16 *	16			27	34	80
TCB50L120CL16	16			27	34	120
TCB50L160CL16	16			27	34	160
TCB50L80CL18 *	18			33	40	80
TCB50L120CL18	18			33	40	120
TCB50L160CL18	18			33	40	160
TCB50L80CL20 *	20			33	40	80
TCB50L120CL20	20			33	40	120
TCB50L160CL20	20			33	40	160
TCB50L100CL25 *	25			44	53	100
TCB50L120CL25	25			44	53	120
TCB50L160CL25	25			44	53	160
TCB50L100CL32 *	32			44	53	100
TCB50L120CL32	32			44	53	120
TCB50L160CL32	32			44	53	160

\* "Face contact" + "D" (DTCB50L80CL18)





DIN/69871

Porta herramientas inducción térmica - Slim  
Shrink Fit holders - Slim execution

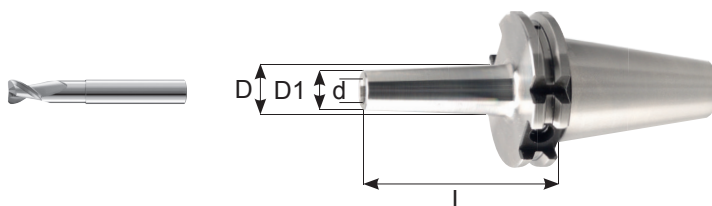

SLIM

TC40

REFERENCIA	d	RPM	FORMA	D1	D	L
TCB40L80CL3SL	3	25.000	AD+B	9	13	80
TCB40L120CL3SL	3			9	16	120
TCB40L80CL4SL	4			10	15	80
TCB40L120CL4SL	4			10	15	120
TCB40L80CL5SL	5			11	16	80
TCB40L120CL5SL	5			11	20	120
TCB40L80CL6SL	6			12	17	80
TCB40L130CL6SL	6			12	19	130
TCB40L160CL6SL	6			12	19	160
TCB40L80CL8SL	8			14	19	80
TCB40L130CL8SL	8			14	21	130
TCB40L160CL8SL	8			14	21	160
TCB40L80CL10SL	10			16	21	80
TCB40L130CL10SL	10			16	23	130
TCB40L160CL10SL	10			16	23	160
TCB40L80CL12SL	12			18	23	80
TCB40L130CL12SL	12			18	25	130
TCB40L160CL12SL	12			18	25	160
TCB40L80CL14SL	14			22	25	80
TCB40L130CL14SL	14			22	27	130
TCB40L160CL14SL	14			22	27	160
TCB40L80CL16SL	16			24	29	80
TCB40L130CL16SL	16			21	31	130
TCB40L160CL16SL	16			24	31	160
TCB40L80CL20SL	20			28	33	80
TCB40L130CL20SL	20			28	35	130
TCB40L160CL20SL	20			28	35	160

7



DIN/69871

Distribuidor rotante de refrigeración  
Side lock oil hole holders

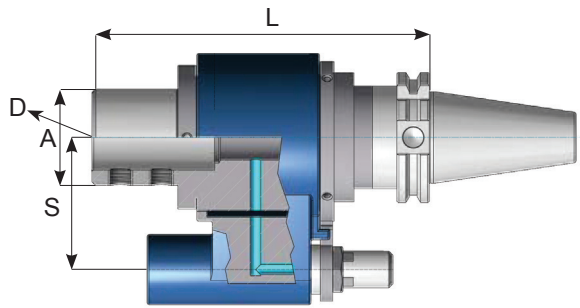

TC40 / TC50

REFERENCIA	D	S	L	A
TC40D16DR	16	65	165	46.5
TC40D20DR	20	65	165	46.5
TC40D25DR	25	65	165	46.5
TC40D32DR	32	65	165	47
TC50D16DR	16	80	165	56
TC50D20DR	20	80	165	56
TC50D25DR	25	80	165	56
TC50D32DR	32	80	170	56
TC50D40DR	40	80	170	56

7

DIN/69871

Distribuidor rotante de refrigeración pinza ER  
ER oil hole holders collet chucks

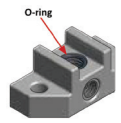
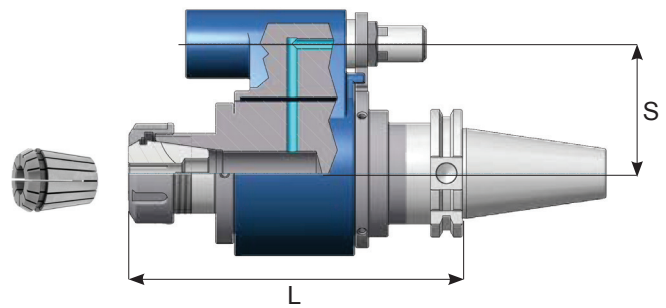

TC40 / TC50

REFERENCIA	CAP	S	L
TC40ER16DR	1 ÷ 10	65	160
TC40ER20DR	1 ÷ 14	65	160
TC40ER25DR	1 ÷ 20	65	160
TC40ER32DR	2 ÷ 22	65	160
TC50ER16DR	1 ÷ 10	80	160
TC50ER20DR	1 ÷ 14	80	160
TC50ER25DR	1 ÷ 20	80	160
TC50ER32DR	2 ÷ 22	80	160
TC50ER40DR	3 ÷ 30	80	160

**DIN/69871**

**Barra mecanizable DIN/69871**  
*Machinable blank Arbors DIN/69871*

**Material : 16MnCr5**  
**600/800 Nm**



**TC30 / TC40 / TC50**

<b>REFERENCIA</b>	<b>D</b>	<b>L</b>
TC30L160D40BL	40.5	160
TC40L250D63BL	63.5	250
TC50L315D95BL	95.5	315



